

Growatt ShineWiFi-F Quick Installation Guideline

For more info, please download from <http://server.growatt.com>

T +86 755 2747 1942

F +86 755 2747 2131

E service@ginverter.com

W www.ginverter.com

Step1. Connection between inverter and Shine WiFi-F module

Plug Shine WiFi-F into the WiFi/GPRS port

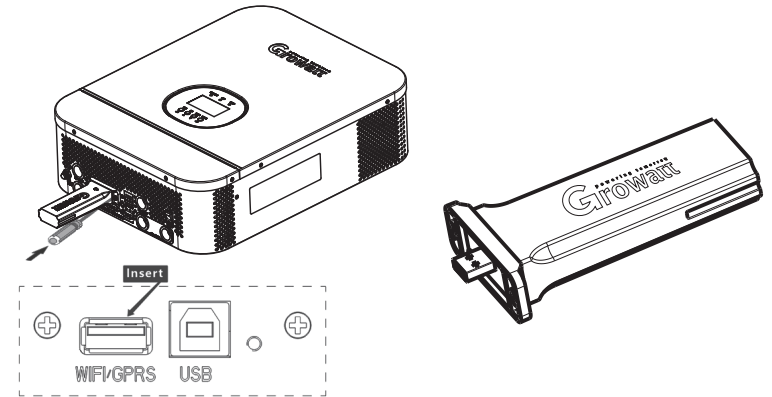

Step2. Turn on inverter and check Shine WiFi-F state

After install the Shine WiFi-F module, turn on the inverter, red LED flashing indicates the inverter and Shine WiFi-F communication is normal.

LED State	Indication
ALL three LED off	datalogger not connected well with inverter WiFi/GPRS port
Only Red LED flashes	ShineWiFi and inverter communication is OK
Only Green LED flashes	ShineWiFi, inverter and router communication is OK
Only Blue LED flashes	ShineWiFi, inverter, router and ShineServer communication is OK

Step3. Registration and adding device

Scan the QR code below to download ShinePhone, also you can search ShinePhone in iOS or Google Play Store, download and install it.

Note: 1. Make sure you download the latest version
2. For further information please visit server.growatt.com



【Android & iOS】

1. Connect your mobile phone to the WiFi of your home router of which the Shine WiFi-F module will be connected.

- 1) The router name should consist with English letters and numbers, it does not support special symbols.
 - 2) For safety reason, please use an encrypted wireless network
 - 3) It does not support a public network that uses a secondary authentication.
 - 4) It does not support bridge network.
2. Open ShinePhone APP, click “Register” on login page.

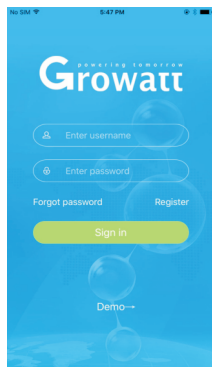

3. Select country and city, then click “Next” enter next page.

Note: If you select a wrong country and city, the system time maybe wrong.

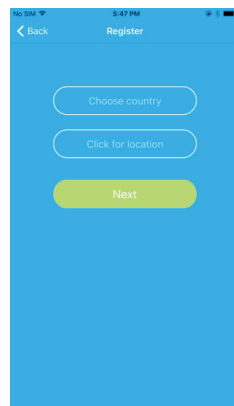

4. Fill out the required information, then click “Next”, it will guide you to the “Add datalogger” page.

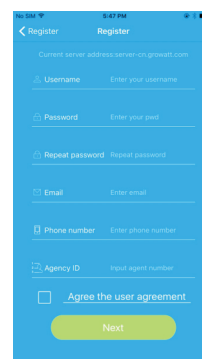

5. Scan or input the ShineWiFi barcode and checkcode, then click “Register”, it will move you to the “Set Shine Wifi-F” page.

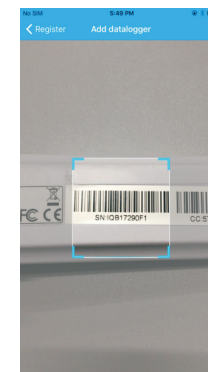
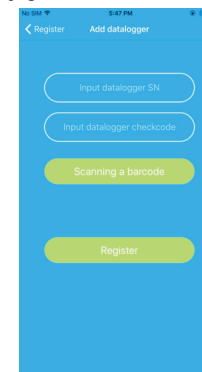

6. Fill out the wifi network and password, then click “Configuration”, after successful configuration, a note will pop up “Configured successfully”, then it will move to the “my plant” page.

Note: There are 3 LEDs on Shine WiFi-F, only the blue LED flashing indicates the Shine WiFi-F module is successfully connected to the router and Growatt Shine Server.

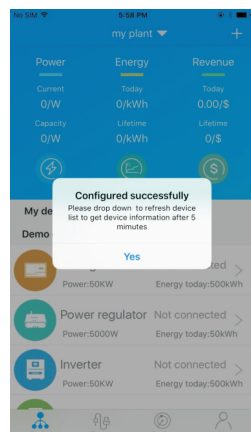
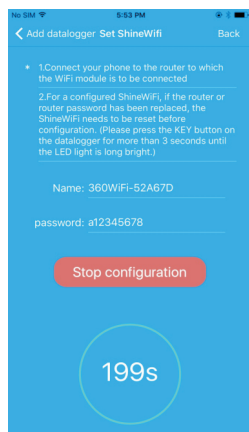

7. If the pop up a message says “Failed”, please refer to Appendix A of the troubleshooting guide to solve the problem. After that, login to your account and click the “+” sign on the right top side of the page, and select “Datalogger list” in the appearing dialog window. Push on the datalogger’s serial number for 3 sec, until a small dialog window appears, select “Configure datalogger”. It will move to the “Set Shine Wifi-F” page, enter the home routers name and password, then click, “Set” the connection configuration process will begin.

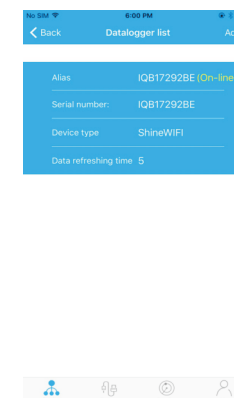
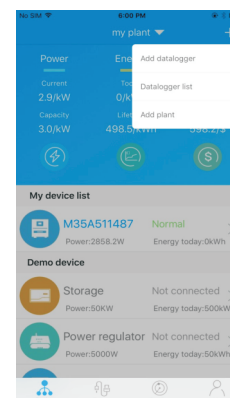

8. After successful configuration, it will move to the “my plant” page, select the inverter in the device list to check the inverter update information.



9. If you want to add/edit/delete/configure a datalogger, click the “+” sign on the right top side of the “my plant” page. There are 4 options in the dialog window when push on the datalogger’s serial number, click the one you need.

- 1) “Add datalogger” is for adding a new Shine WiFi-F module to this account.
- 2) “Edit datalogger” is used to assign an alias name for your Shine WiFi-F module.
- 3) “Delete datalogger” is used to remove the Shine WiFi-F module from this account.
- 4) “Configure datalogger” is used for configuring the connection of the Shine WiFi-F module to the router.

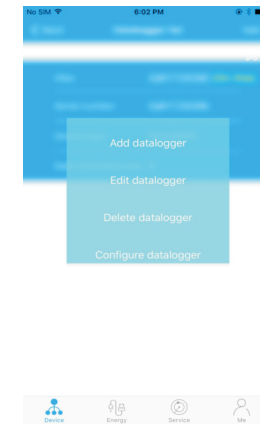
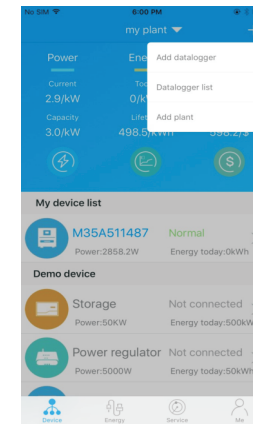

Step 4. Reset Shine WiFi to Factory Settings

When you have changed your home router password, or changed to a new router, you need to reset Shine WiFi-F to factory settings and reconfigure it. Remove the rubber plug, and press the KEY button for 6 sec, until all three LEDs long light up, then login to your ShinePhone account, click the “+” on right top of this page, long press this datalogger serial number to reconfigure.

Appendix A: Shine WiFi-F KEY Button Description

Operation	Description
When Shine WiFi-F is powered on, remove the rubber plug, and press the KEY button. (Shine WiFi-F LED will change from flash to always ON)	Shine WiFi-F will enter to AP mode. (AP mode is a debug mode, only allowed for professional)
When Shine WiFi-F in AP mode, press The KEY button of ShineWiFi (Shine WiFi-F LED will change from always ON to flash)	Quit AP mode
Long press the KEY button for More than 6 sec (Shine WiFi-F All LEDs always ON)	Reset Shine WiFi-F to Factory settings

Troubleshooting

LED State	Indicate	Troubleshooting
All three LEDs are dark	Shine WiFi-F can not find inverter via WiFi/GPRS port	1. Check if the DIP switch beside inverters WiFi/GPRS port is switched DIP1 to “ON”
After configuration, only Red LED flashes	Shine WiFi-F can’t connect to the home router	(1) Check router information a) Router name should consist of English letters and numbers, it does not support special symbols b) For safety reason, please use encrypted wireless network c) It does not support public network that use secondary authentication (2) Check if you filled in the correct name and password of the home router when configuring it
After configuration, Only Green LED flashes	Shine WiFi-F already connected to the home router, but not connected To Growatt ShineServer	(1) Check if home router is connected to the internet (2) Check if the router firewall allows to select port 5279 and 5280
After configuration, Only Blue LED flashes	Shine WiFi-F communication OK with inverter, home router, and Growatt ShineServer	Normal working state
Red LED always ON	Shine WiFi-F module error	Need to replace with a new Shine WiFi-F
Green LED always ON	Shine WiFi-F module in switching mode	No response if you press the KEY button during this period
Blue LED always ON	Shine WiFi-F module is in AP mode	Debug mode, short press the KEY button to quit